

# DELTA

PREVENTION



VSS SYSTEM Installation Guide





- The surface on which the posts and the counterweights will lay must be free of debris to allow a proper adhesion to prevent the guardrail to slide, thus creating an efficient level of safety.
- The guardrails should not be used as anchorage points for workers fall protection equipment. They were not conceived for this type of protection and would not support the loads incurred in case of a fall.

## PARTS

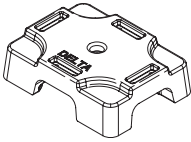

RUBCW

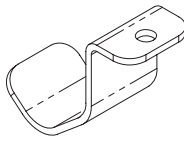

JCLIP



JCBOLT



JCWASHER



PLC

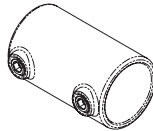

CL10



CL90

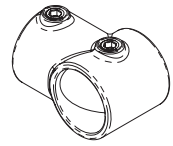

CL101



CL125



CL148

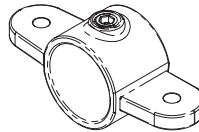

CL167

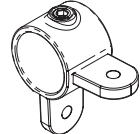

CL168

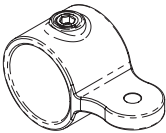

CL173

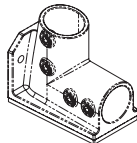

CL200

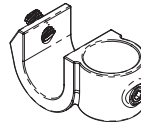

CL201

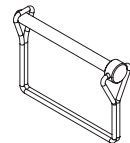

LOCKPIN

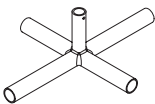

CKIT



CKITSL12



SLBOLT



SLNUT

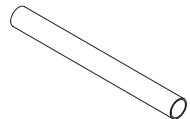

ALTUB18.5

## PARTS (CONTINUED)

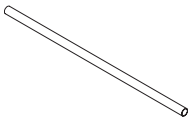

ALTUB55

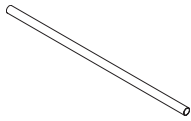

ALTUB75

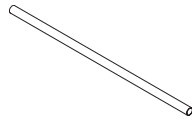

ALTUB240

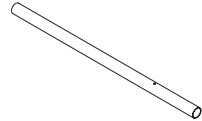

ALTUB35.75

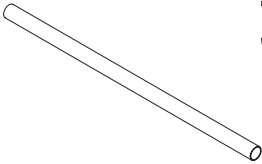

ALTUB42

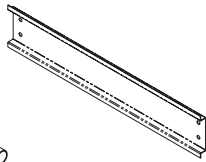

KP120

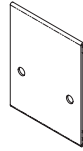

KPBR

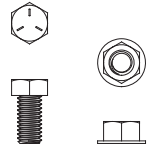

KPBOLT

KPNUT

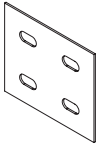

KPJB

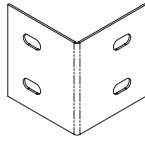

KPBC



YSW

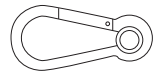

SNAPHOOK

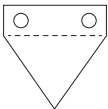

FLAG



ATTSF

## TOOLS



Cordless hammer drill  
[20V battery recomm.]



$\frac{5}{16}$ " socket



#8 Allen socket



Measuring tape



Level



Torque wrench



Outil de coupe pour tuyaux



**OPTIONAL:**  $\frac{5}{16}$ " socket  
for kick plate

## PROTECTION GEAR



Helmet



Goggles



Boots



Harness

# VSS CLASSIC



## NOTICE

- In case of an installation on a free-parapet roof, the guardrail must be installed at a minimum of 12" from the edge.
- A corner following a section more than 8'8" long must measure at least 4'4".
- A self-standing corner must have at least a 4'4" side and an 8'8" side.

1

Lay out the CL200 bases according to the following maximum distances to ensure compliance with installation standards. These distances can be shortened in case of obstacles.

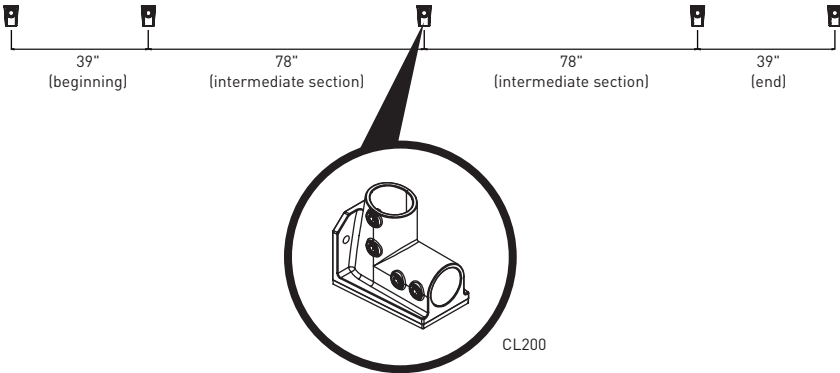

Note: for a 10' guardrail, refer to page 7.

2

Lay out the DCS1, DCS2 and DCS3 components towards their CL200 respective base.

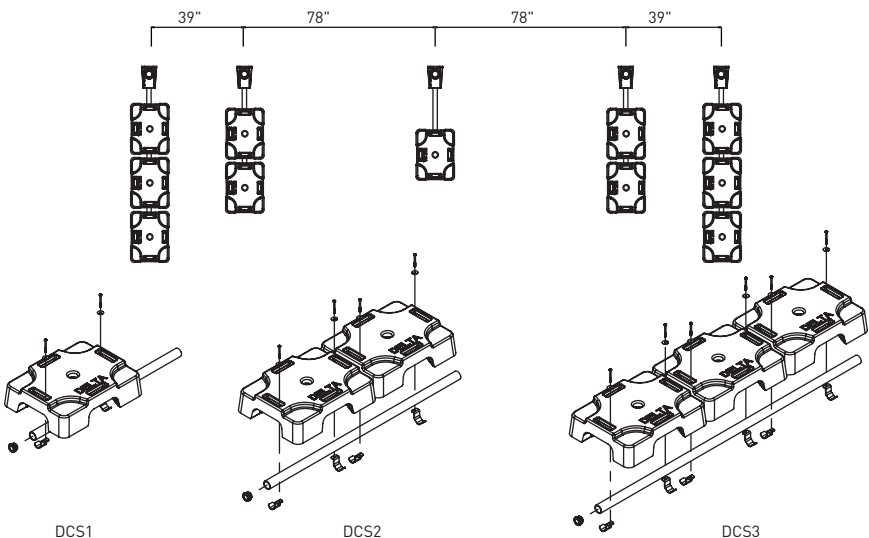

3

Assemble each DCS1, DCS2 and DCS3 by tightening the JCBOLT with the hammer drill and the  $\frac{7}{16}$ " socket in order to reach the compaction point of the DELTAMAX base. The tube end with the PLC plastic cap must be at the opposite of the CL200 base.

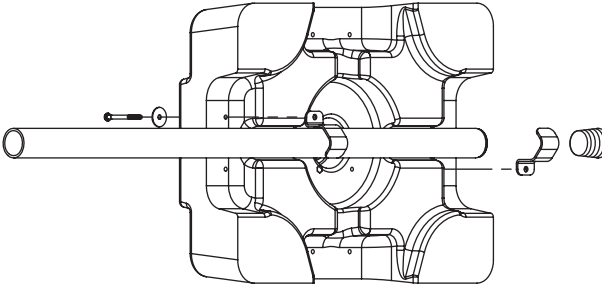

**Tip:** place the DELATAMX base on its side to easily install the 1.9ALTUB42, 1.9ALTUB55 or 1.9ALTUB75 tube using the JCLIP, the JCBOLT and JCWASHER.

4

Insert the DCS1, DCS2 and DCS3 assemblies in their CL200 respective base leaving enough space to stabilize the VPS42 vertical post (step 5) at the bottom of the base.

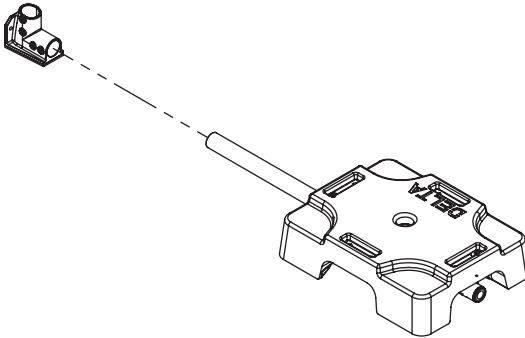

5

Insert the top part of the VPS42 in each CL200 base. Make sure the vertical post is well stabilized at the bottom of the base and direct each CL201 towards a counterweight. Tighten at 30 lb-ft only both fastening screws at the bottom of the base.

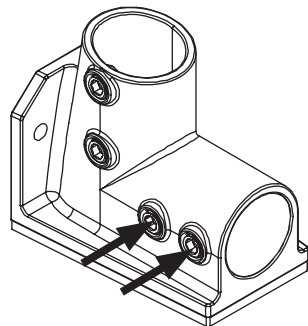
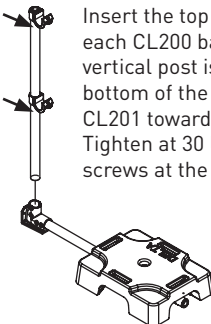

6

Insert the 1.9ALTUB240 tubes in the upper and lower CL201 to create the handrail. A 20" section will be required at both ends to create the "D" extensions. If needed, cut the corners and the joints depending on the length of the guardrail.

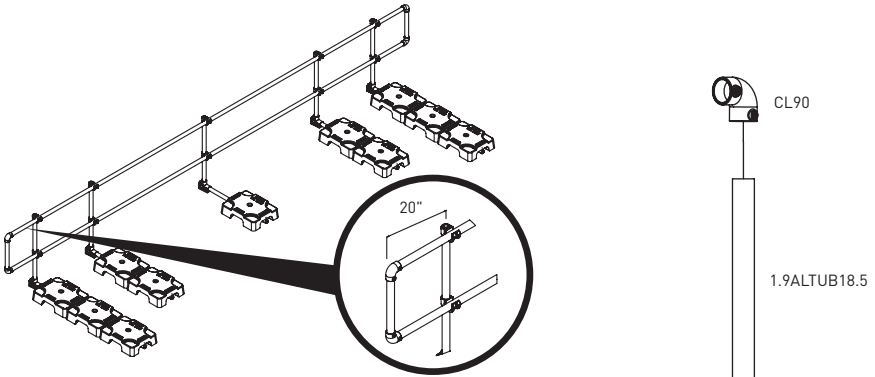

**6,1** To create the "D" extensions, use two CL90 and the 1.9ALTUB18.5 tube. Tighten at 30 lb-ft the fastening screws of each CL90 connector. ▶

**6,2** The tubes must be installed so that the joints do not overlap. Use the CL10 connector to combine two tubes. Never align two CL10 connectors one above the other. Tighten at 30 lb-ft the two fastening screws of the CL10 connector.

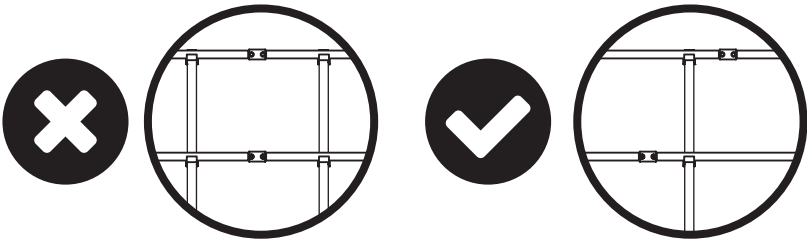

7

Level the VPS42 and tighten at 30 lb-ft both fastening screws

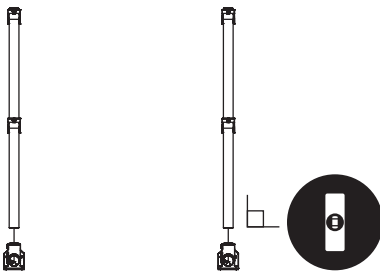

8

Tighten at 20 lb-ft the fastening screws of all the CL201 to secure the handrails.

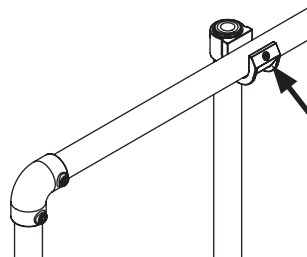



### OPTIONAL – Guardrail with angle.

To create a variable angle, use the CL125 connector.

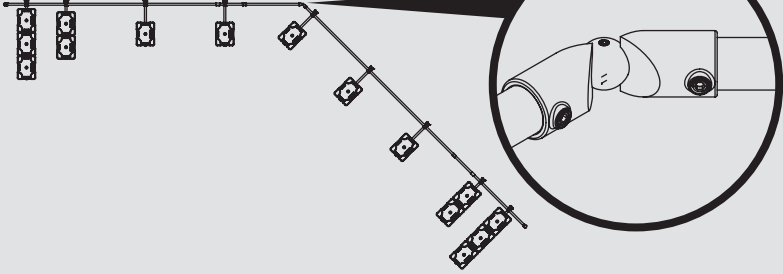

### OPTIONAL – Kick plate.

When necessary, the addition of a kick plate is possible with the VSS CLASSIC.

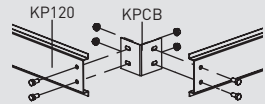
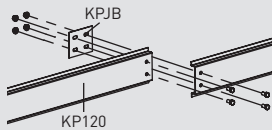
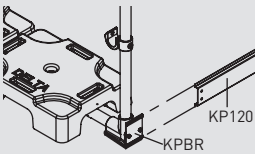
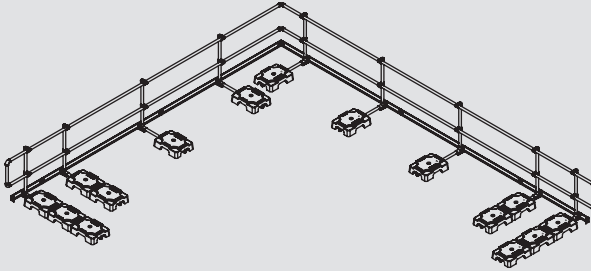

### OPTIONAL - 10' Guardrail (minimum length)

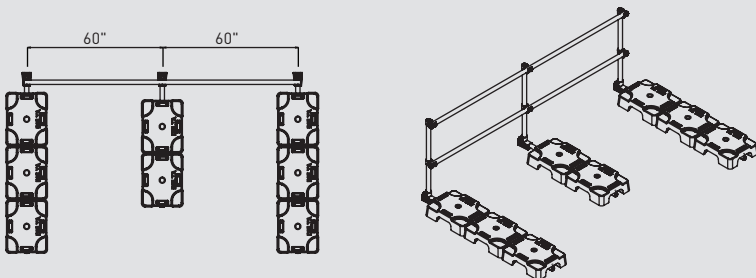

# VSS COMPACT



## NOTICE

- For the VSS COMPACT, 60" full height returns are mandatory at both ends only but cannot be considered as a guardrail section.
- In case of an installation on a parapet-free roof, the guardrail must be installed at a minimum of 12" from the edge. Furthermore, extra 60" returns must be added every 40' and linked to the main handrail using the CL101 connector.

1

Lay out a preassembled DELTAMAX base every 10' maximum, at each corner and each end according to your configuration.

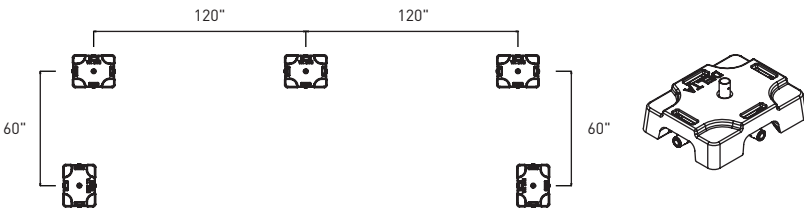

2

Insert the 12" CKITSL12 sleeve in the end of each CKIT of the preassembled bases. Fasten with SLBOLT bolt and SLNUT nut.

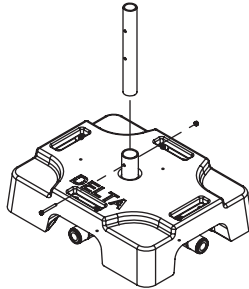

3

Lay down the remaining DELTAMAX bases on the preassembled bases.

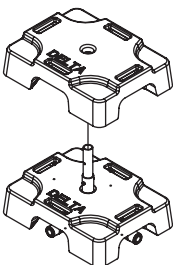

4

Insert the vertical post on the CKITSL12 sleeve and secure with the LOCKPIN.

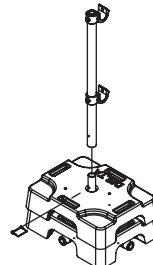



5

Insert the 1.9ALTUB240 tubes in the upper and lower CL201 to create the handrail. If needed, cut the corners and the joints depending on the length of the guardrail. The tubes must be installed so that the joints do not overlap. To create the 5' return at both ends, allow an extra 3" in the handrail in order to fit the two CL90, then cut a 1.9ALTUB240 in four sections of 5' each. Tighten at 30 lb-ft the fastening screws of each CL90 connector.

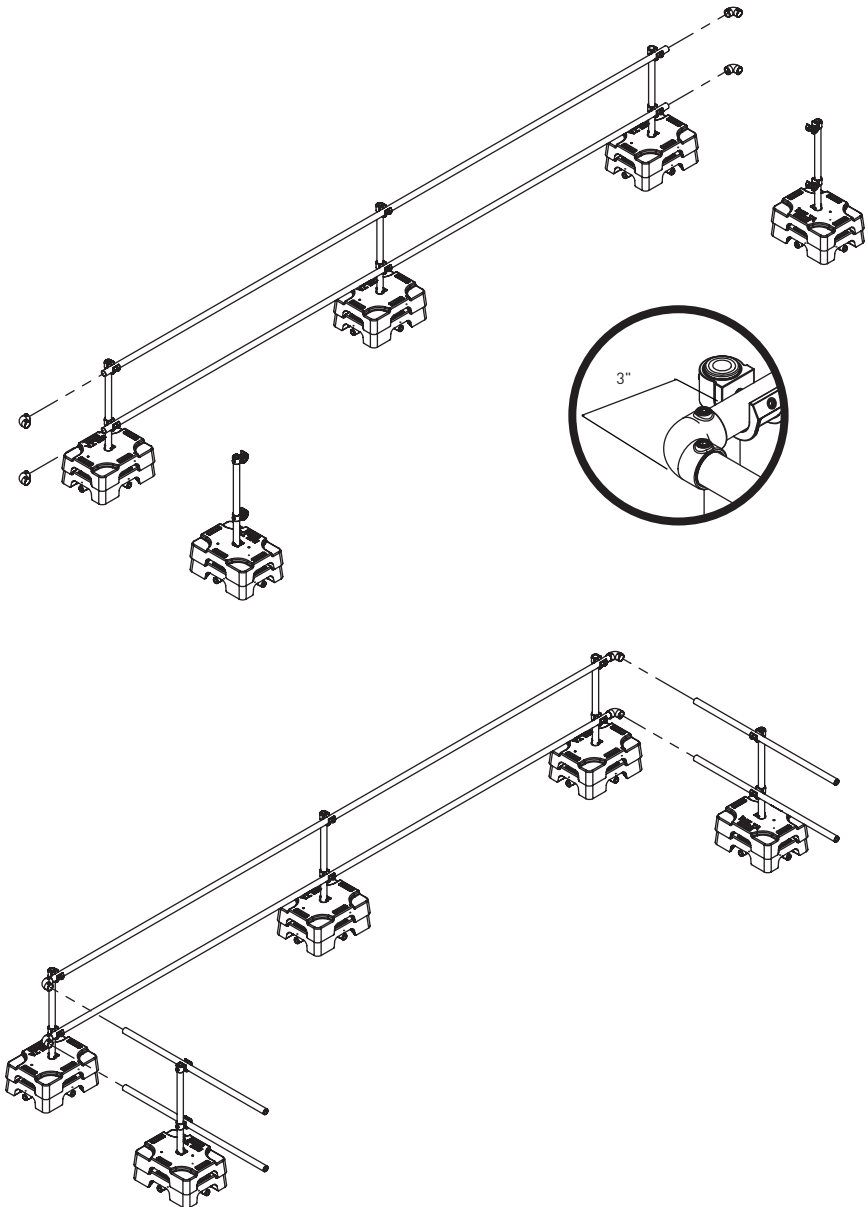

5

(CONT'D)

Use the CL10 connector to link two tubes. Never align two CL10 connectors one above the other. Tighten at 30 lb-ft the two fastening screws of the CL10 connector.

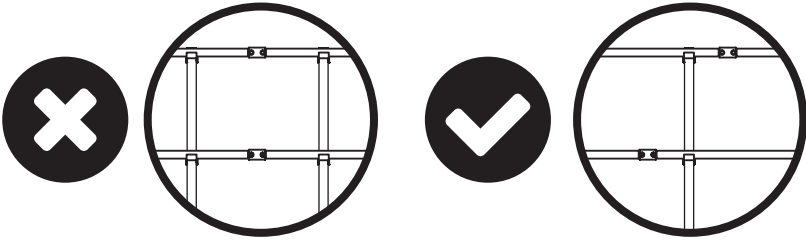

6

Tighten at 20 lb-ft the fastening screws of all the CL201 to secure the handrails. Insert the PLC plastic caps at each of the four ends.

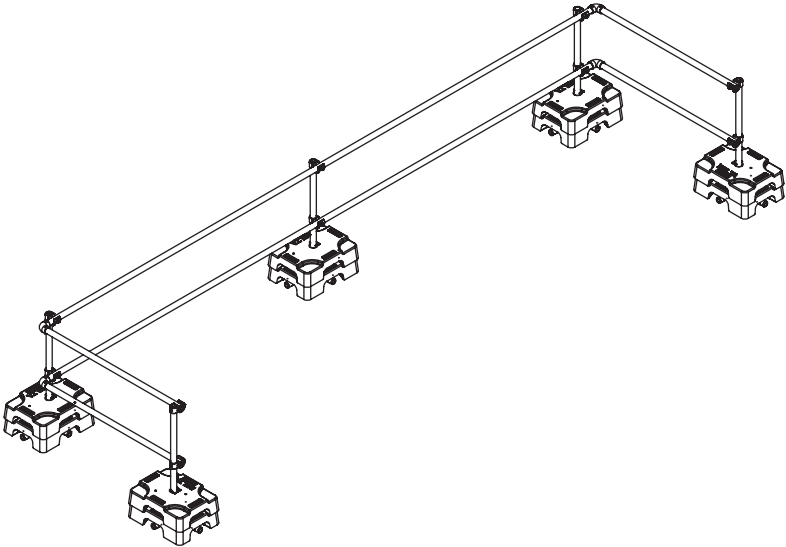

# VSS SAFETYLINE



## NOTICE

- The VSS Safety Line must ALWAYS be installed at more than 6'6" from the edge of the roof.

1

Lay down the DELTAMAX preassembled bases according to your type of configuration.

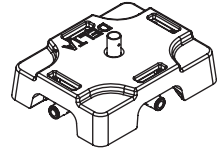
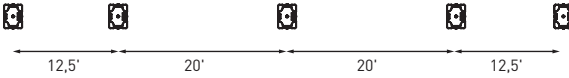

2

Insert the 12" CKITSL12 sleeve in the end of each CKIT of the preassembled bases. Fasten with SLBOLT bolt and SLNUT nut.

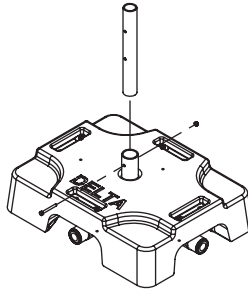

3

Lay down the remaining DELTAMAX bases on the preassembled bases.

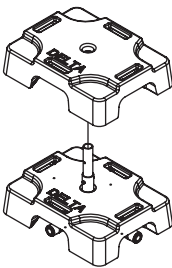

4

Insert the vertical post on the CKITSL12 sleeve. Secure with the LOCKPIN.

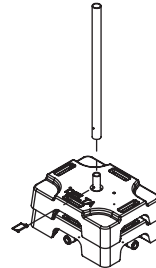

5

Install the fittings CL167 (center), CL168 (corner) and CL173 (end) on the vertical posts at 39" from the ground. (measured above)

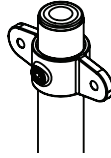
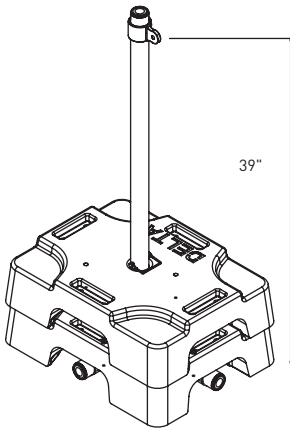

CL167

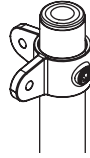

CL168



CL173

6

Link the DSL2 with the YSW preassembled cables (150", 240") using the carabiners. The middle of the cable must be between 30" and 34" from the ground.

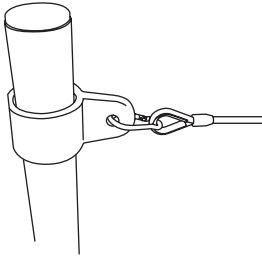

7

Install the SFLAG security flags with the ATTSF plastic ties. Put two flags for each section of 150" and three flags for each section of 240". The distance between each flag must be 72".

